

921-3xx

Lv7 2020-r5

Modelo-model:

CRUZ Oplus ST

ES	Instrucción de montaje ¡Leer primero!	Barras de acero
EN	Assembly instructions Read first!	Steel bars
FR	Instruction de montage Lire en premier!	Barres d'acier
DE	Montageanleitung Zuerst lesen!	Stahldachträger
PT	Instruções de montagem Ler primeiro!	Barras d'aço
IT	Istruzioni di montaggio Leggere per primo!	Barre d'acciaio
NL	Montagehandleiding Eerst lezen!	Stalen dakdragers
PL	Instrukcja montażu Najpierw przeczytaj!	Belki stalowe
CZ	Montážní návod Čtěte pozorně!	Ocelové střešní nosiče
HU	Szerelési Utasítás Először olvassd el!	Acél rudak
HR	Detaljne upute Prvo procitaj!	Bare din otel
RO	Instructiuni de montaj Intai cititi!	Čelične šipke
RU	Инструкции по монтажу Сначала прочитайте!	Стальные поперечины
GR	Διαβάστε προσεκτικά τις Οδηγίες Συναρμολόγησης!	Μπάρες Σιδερέ
TR	Öncelikle montaj: Talimatlarını okuyunuz!	Çelik barlar
SI	Navodila za sestavljanje Preberite!	Jeklene prečke

Lote-Lot-Lot-Lot:



Peso-Weight-Poids-Gewicht:

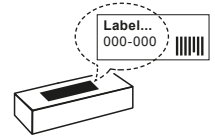

Kit A: **Max. 60 kg / 132 lbs**
Kit B: **Max. 75 kg / 165 lbs**

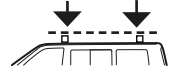

CEE - EEC type approval:



26 R- 04 3015







CITY CRASH (↩)

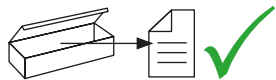

CRUZBER SAU
ES-A14018311
P.I. Las Salinas II
14960 - Rute - Spain
www.cruz-products.com

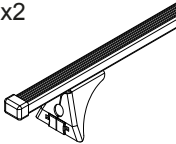

1.

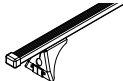

ES	Contenido embalaje: ¡Verificar!	x1		x1
EN	Package content: Check!			
FR	Contenu d'emballage: Vérifier!			
DE	Packungsinhalt: Überprüfen!	x2		x1
PT	Contéudo embalagem: Verificar!			
IT	Contenuto della confezione: Controllare!			
NL	Pakket inhoud: Controleer!			(853-050)
PL	Zawartość opakowania: sprawdź!			
CZ	Obsah balení: Zkontrolujte!			
HU	Csomag tartalma: Ellenőrizd!			
HR	Sadržaj paketa: Provjeri!			
RO	Pachetul contine: Verificati!			
RU	Содержание упаковки: Проверьте!			
GR	Ελέγξτε το περιεχόμενο: του πακέτου!			
TR	Paket içeriğini: Control ediniz!			
SI	Vsebina paketa: Preverite!			

Código Code		↔		Lote Lot
921-305	ST-110 (822-009)	110 cm / 43"	4,86 kg / 10,71 lbs	05/15
921-310	ST-120 (822-019)	120 cm / 47"	5,12 kg / 11,29 lbs	06/15
921-315	ST-130 (822-029)	130 cm / 51"	5,32 Kg / 11,73 lbs	05/15
921-317	ST-135 (822-034)	135 cm / 53"	5,45 Kg / 12,01 lbs	05/15

2.





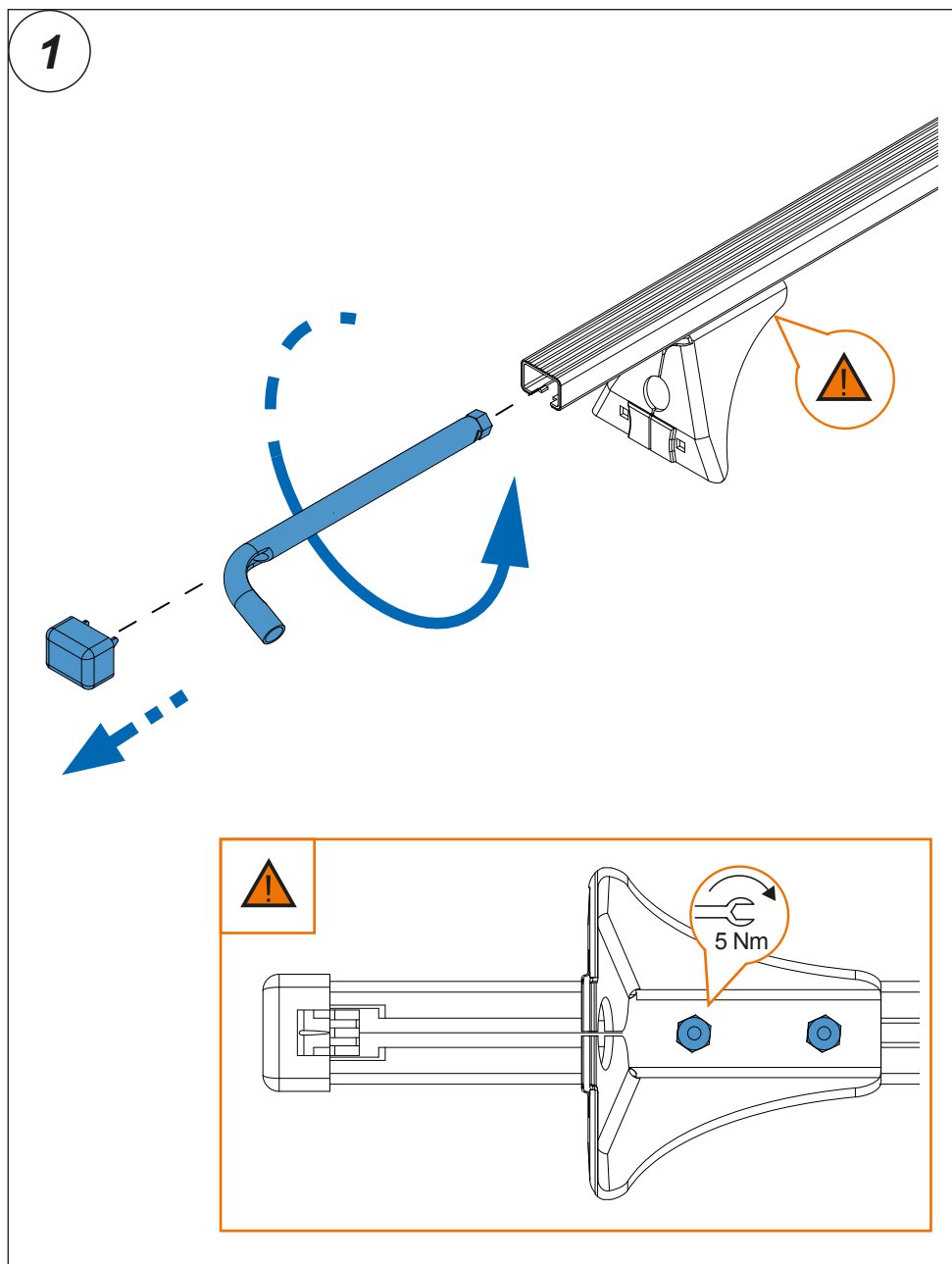

Importante!
Important!
Important!
Wichtig!

- ES Estas barras tienen que usarse con Kits de fijación CRUZ!
- EN Bars must be used with CRUZ fixation Kits!
- FR Les barres devront être utilisées avec les Kits de fixation CRUZ!
- DE Die Dachlsträger nur mit CRUZ Stützfuß-Kits befestigen!
- PT As barras devem ser utilizadas com os Kits de fixação CRUZ!
- IT Questa bare deve essere utilizzato solo con il kit di fissaggio CRUZ!
- NL Dakdragers moeten worden gebruikt in combinatie met de bevestigingssets van CRUZ!
- PL Belki muszą być stosowane z elementó w mocujęcymi firmy CRUZ!
- CZ Tento nosič musí být používán s fixačním kitem CRUZ!
- HU A rudakat csak CRUZ rögzítő készlettel szabad használni!
- HR Šipke moraju biti korištene sa CRUZ kitovima za montažu!
- RO Barele trebuie utilizate cu Kit-uri de fixare CRUZ!
- RU Поперечины должны быть использованы со специальным крепежным комплектом CRUZ!
- GR Το αξεσουάρ αυτό θα πρέπει να χρησιμοποιείται αποκλειστικά στα συστήματα μπαρών της CRUZ!
- TR Bu barlar mutlak CRUZ montaj kiti!
- SI Prečke je potrebno uporabiti s CRUZ kiti za pričvrščanje

3. 



4. 

2   →   → **2**

3

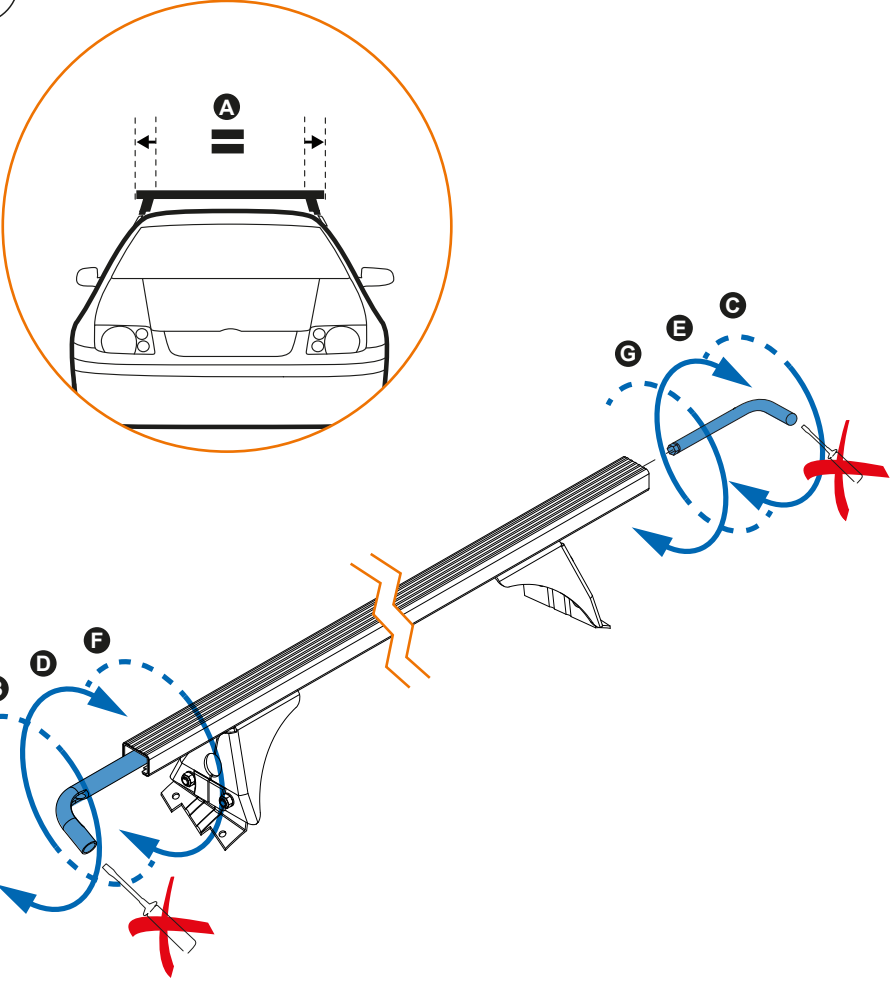

The diagram illustrates the correct installation of a roof rack. The circular inset shows the car with the roof rack installed, labeled 'A' with an equals sign and arrows pointing outwards. The main diagram shows a detailed view of the roof rack with a blue L-shaped bracket being inserted into a slot. Labels B, D, and F are near the bracket's end, and labels C, E, and G are near the bracket's tip. Red 'X' marks indicate incorrect insertion directions.

5. 

